



CATALOGUE
DES PRODUITS
BOÎTIERS ÉLECTRIQUES ET CABINETS



20

DOUBLE DOOR ENCLOSURE FOR CENTER POST MOUNTED DISCONNECT

The 5500 UCD oil and dust tight center post mounted safety disconnect enclosures are used indoors for protection against dirt, dust, oil and water splashing. The 5500 UCD are made of high quality code gauge steel with all seams continuously welded. The center post can be removed to facilitate the installation of the inner panel. The ball bearing pins of the concealed die cast hinges can be easily pulled out to remove the doors. Three point automotive padlockable handles

ensure positive closing on both doors. The new latching rod system interlocks with the disconnect handle and eliminates the need to purchase an adaptor. A door interlock is installed to ensure that the right hand door (slave) can only be opened if the left hand door (master) is open and the disconnect switch is powered off. Enclosures have 15" floor mounting feet installed. Door and body stiffeners are provided on larger models. Each enclosure comes complete with a galva-

nized inner panel, which mounts on M10 welded studs. A print pocket is provided. Enclosures are finished with heat fused powder paint, electrostatically applied on a pretreated base. Box is ANSI/ASA 61 smooth gray. Inner panel is galvanized (other colors available).

**CSA Certified / UL Listed
NEMA/EEMAC 12-13 / IP55**

**Refer to p.734 to validate
choice of substrate for the
application**

If the 5500 UCD is to be used with a flange mounted disconnect switch or a circuit breaker, the following items must be ordered:

Ordering an Allen-Bradley 1494V Disconnect switch

- an operating mechanism with the disconnect switch 1494V
- an operating handle 1494V-H1
- a connecting rod 1494V-RA1 if the enclosure is 8" deep or 4VRA2 if the enclosure is 12" deep
- if required, a trailer fuse block kit 1494V, a fuse clip and line and load connectors.

Circuit breaker

- a Westinghouse or General Electric circuit breaker.
- an operating mechanism 1494V
- an operating handle 1494V-H11
- a connecting rod 1494V-RA1 if the enclosure is 8" deep or 4VRA2 if the enclosure is 12" deep

Ordering a Cutler Hammer Disconnect switch catalog C361

- an operating mechanism with the disconnect switch
- an operating handle (C361-H2 or H4)

Circuit breaker operators catalog C371

- a Cutler hammer or Westinghouse circuit breaker
- an operating mechanism
- an operating handle

Ordering a Square D Class 9422 Disconnect switch

- an operating mechanism with the disconnect switch class 9422
- an operating mechanism handle class 9422 Type A-1

Circuit breaker

- a Square D circuit breaker
- an operating mechanism class 9422
- an operating mechanism handle class 9422 Type A-1

Ordering a General Electric Disconnect switch

- a disconnect switch QMR or QMW
- a fuse clip kit if required
- a TDAI flange handle
- an operating mechanism, variable depth

Circuit breakers

- a circuit breaker
- a TDAI flange handle
- an operating handle 1494V-H11
- an operating mechanism, vari-

able depth

Ordering an Asea Brown Boveri Disconnect switch

- a switch flange operated fuse if required
- a DSFHS-12 shaft
- a DSFHN-HS12 handle

Circuit breaker

- a circuit breaker
- an operating mechanism
- a FHS-12 shaft
- a FHN-HS12 handle

Ordering an I-T-E Max-Flex™ Disconnect switch

- a basic right hand switch
- a fuse kit if required
- a handle FHOHS flange mounted
- an operator FHOSO6R
- a cable FHOECO36

Circuit breaker

- a circuit breaker
- a set of pressure wire connectors
- a handle FHOH flange mounted
- an operating mechanism
- a standard cable 36"

Ordering a Westinghouse Disconnect switch

- a disconnect switch or circuit breaker type DS
- a yoke assembly and backplate
- a rod and brace assembly
- a pivot mechanism
- an operating handle

Disconnect switches and operating mechanisms are not furnished with the enclosures.

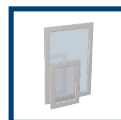

p.554

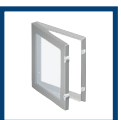

p.552



p.538

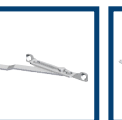

p.527

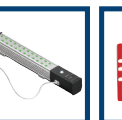

p.556



p.539



p.543

DOUBLE DOOR ENCLOSURE FOR CENTER POST MOUNTED DISCONNECT

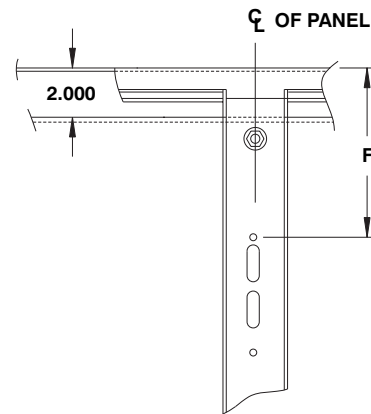
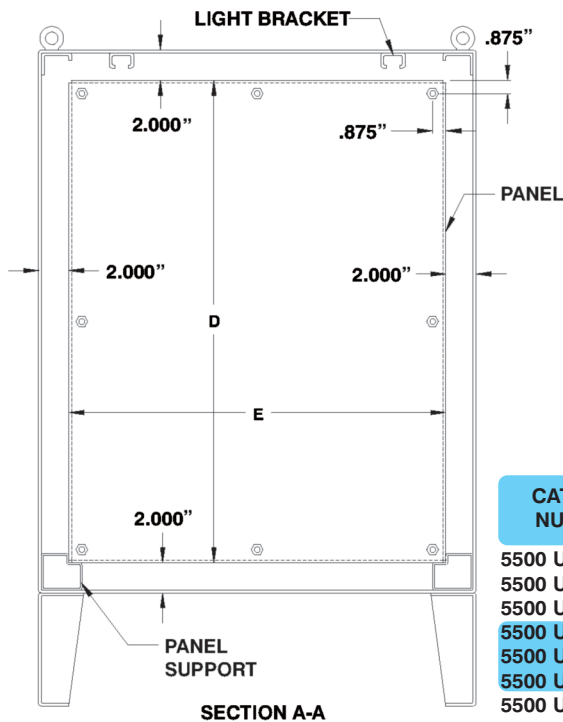
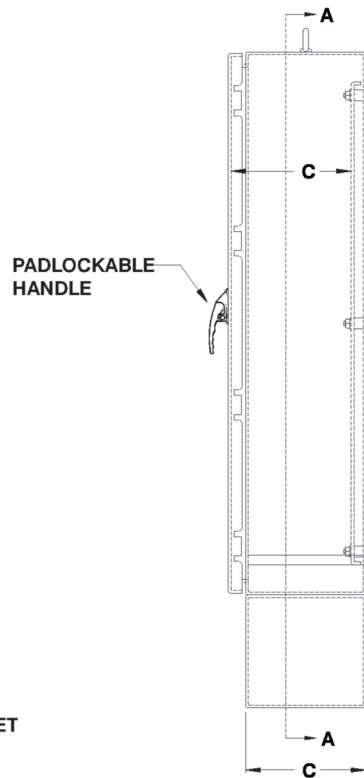
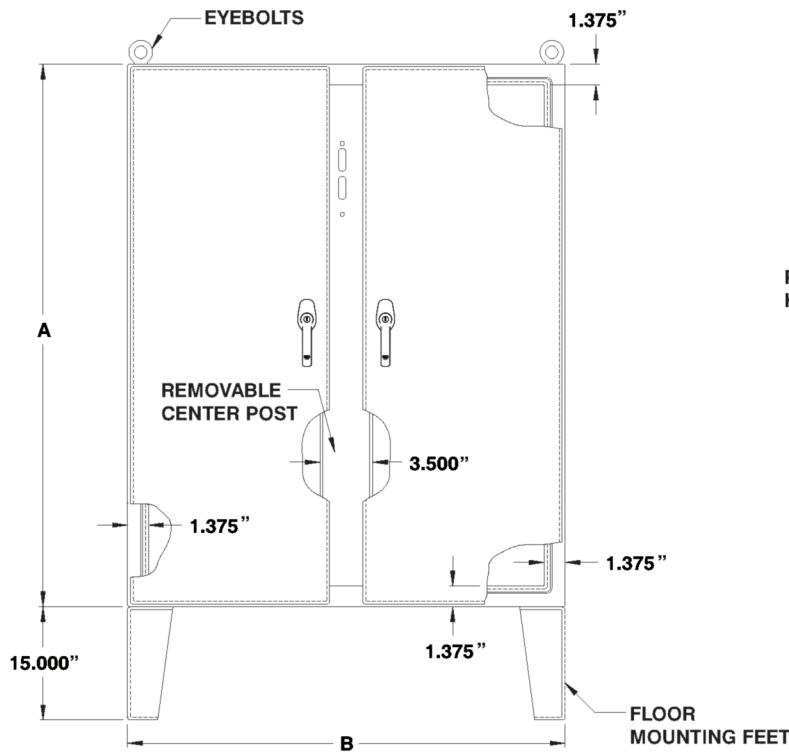

CATALOG NUMBER	DIMENSIONS						SHIP WGT LBS.
	A	B	C	D	E	F	
5500 UCD604812	60	48	12	56	44	7.875	540
5500 UCD606012	60	60	12	56	56	7.875	669
5500 UCD726012	72	60	12	68	56	13.875	787
5500 UCD727212	72	72	12	68	68	13.875	920
5500 UCD727218	72	72	18	68	68	13.875	1000
5500 UCD604824	60	48	24	56	44	7.875	701
5500 UCD606024	60	60	24	56	56	7.875	830

* For Allen Bradley Bulletin 1494F and 1494D disconnect switch piercings, add suffix 'AB' to the catalog number. (Example: 5500 UCD606012AB) Custom piercings are available upon request.

